

Active LFG Control: An Unreliable Aid to Veneer Stability

Gregory N. Richardson, Ph.D., P.E.
Stacey A. Smith, P.E.
Pieter K. Scheer, P.E.

Presented by:
Pieter K. Scheer, P.E.



Typical Geosynthetic Final Cover System

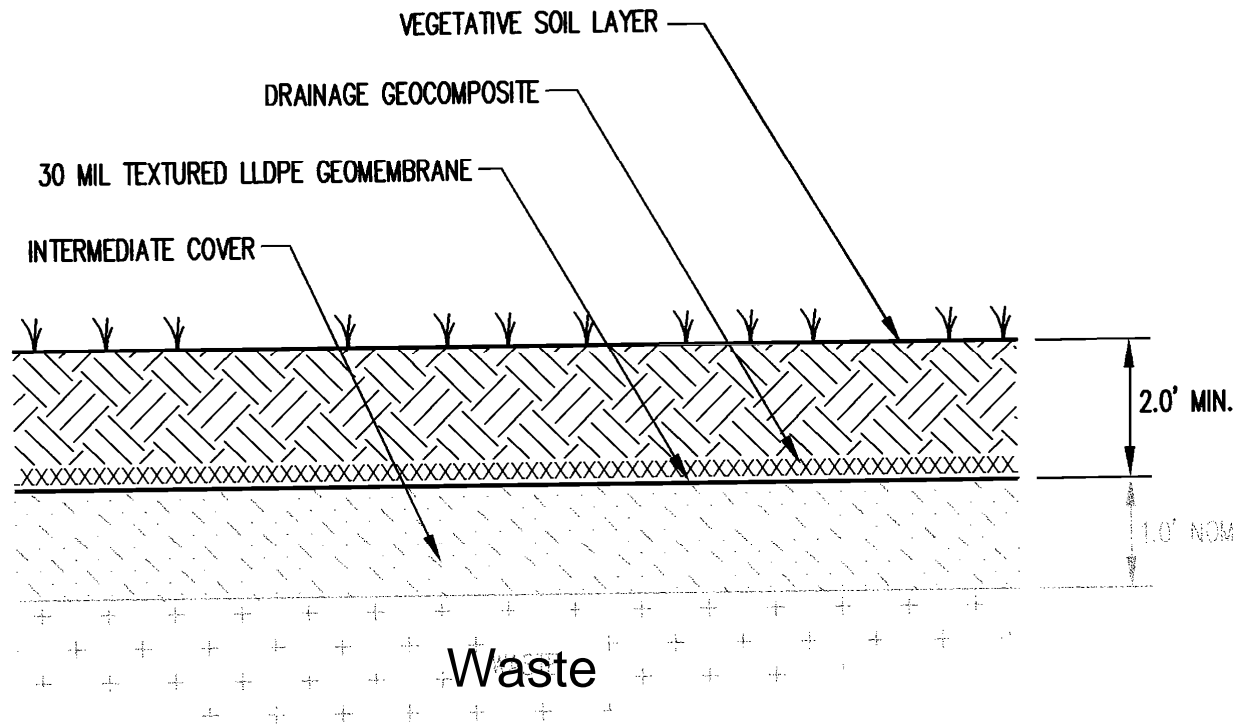

Typical Piggyback (Waste Over Waste) Liner System

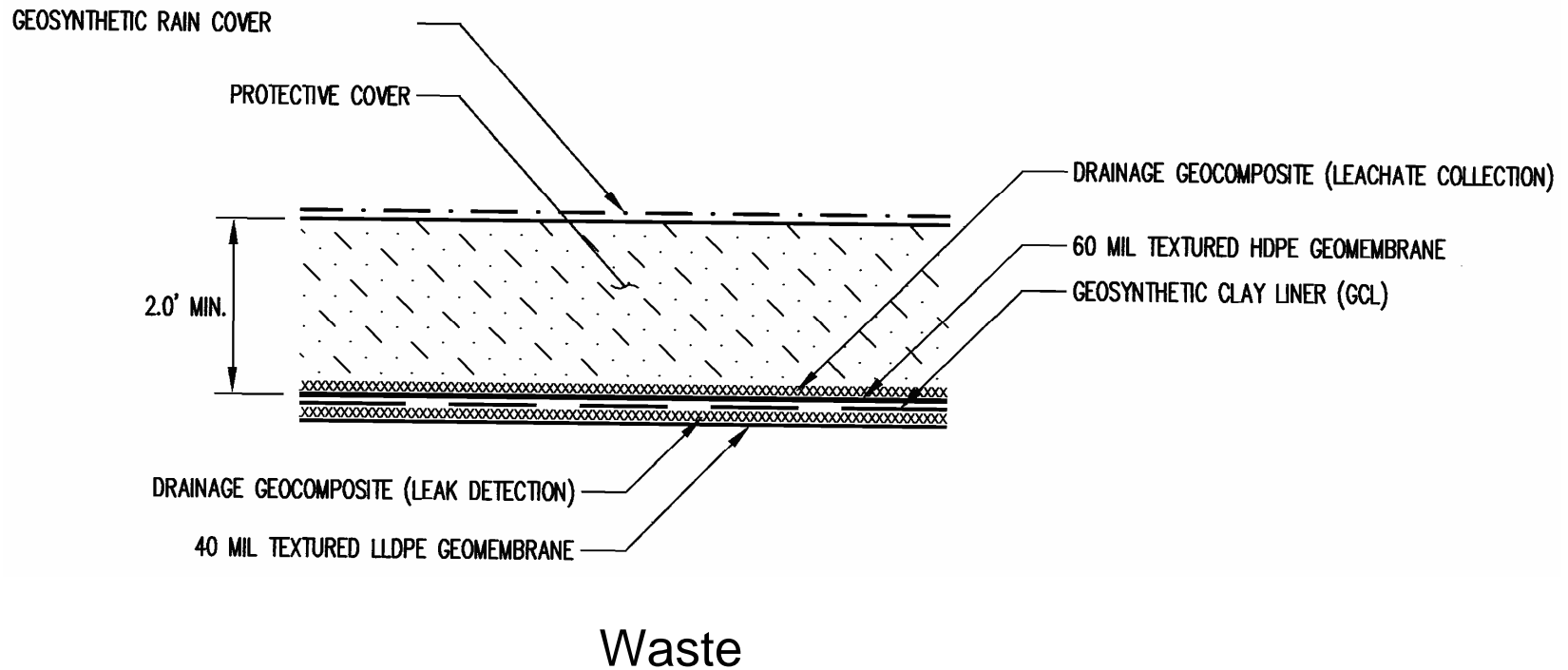

Slope Stability: LFG Related

$$FS = \frac{(W - u_{LFG}) \cos \beta \tan \phi + a}{W \sin \beta} \quad \text{Eq. 1}$$

The variables in Equation 1 are defined as follows:

- $W =$ weight of final cover system above the GM (psf),
- $u_{LFG} =$ LFG pressure (psf)
- $\beta =$ slope angle (degrees)
- $\phi =$ interface friction angle (degrees)
- $a =$ interface adhesion (psf)

LFG Pressure at Limit of Sliding Stability

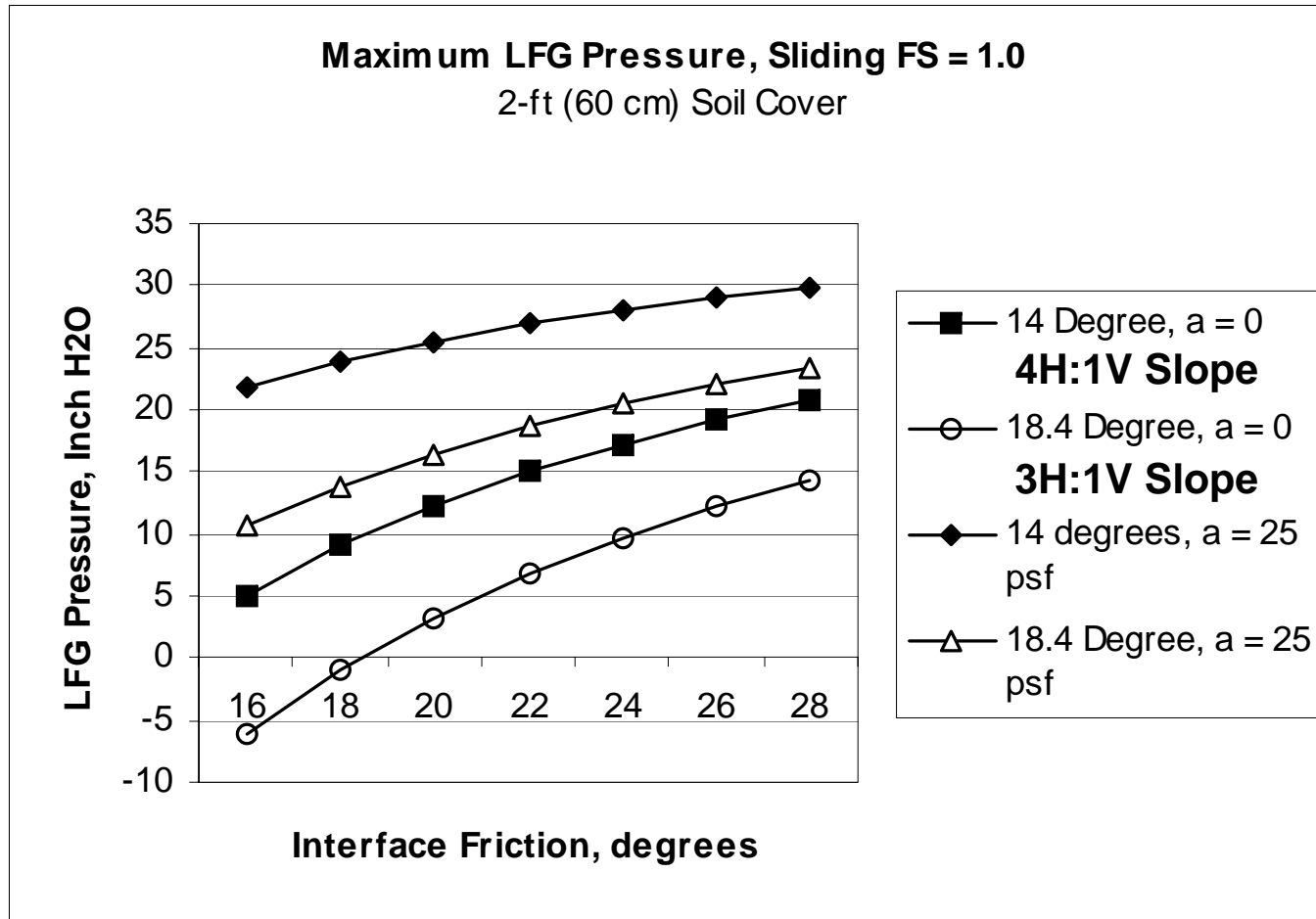

Passive LFG Relief/Collection Systems (vs. Active LFG Systems)



While active LFG systems rely on a regularly spaced network of gas wells.....



Passive LFG systems are systems that rely on gravel “French drains” or area collectors placed at/near the surface of the waste.

Passive LFG Relief/Collection Systems (vs. Active LFG Systems)

Things to Note:

- Passive LFG systems are commonly empirically designed as there is typically a high degree of uncertainty about LFG generation rates.
- Active LFG wells typically have solid piping extending 10 to 20 feet below the final cover system in order to limit air intrusion.
 - Thus, by design, the effectiveness of an active LFG system to minimize pressure on the final cover veneer is limited.
- For the wrong combinations of slope, interface shear strength, gas pressure, etc. failures have resulted.....

Case Study: Failure During Construction

Exposed
GCL



Final Cover System on 4H:1V slope with components (top-down):

- 1.5-ft topsoil and vegetative soil;
- 1-ft sand drainage layer;
- PVC geomembrane;
- GCL having nonwoven side down, slit film side up;
- 1-ft thick LFG relief layer of fine sand; and
- Interim cover/structural layer immediately over waste.

Case Study: Failure During Construction

- Failure occurred along PVC geomembrane/GCL interface before placement of final 1.5-ft of soil.
- PVC GM/GCL interface ($\phi = 16$ degrees; $a = 11$ psf) (not very robust) theoretically stable ($FS > 1.0$) at < 10 inch- H_2O LFG pressure.
- Average LFG pressure of 6.6 inch- H_2O and a maximum LFG pressure of 16 inch- H_2O were measured after failure.



Case Study: Failure During Construction

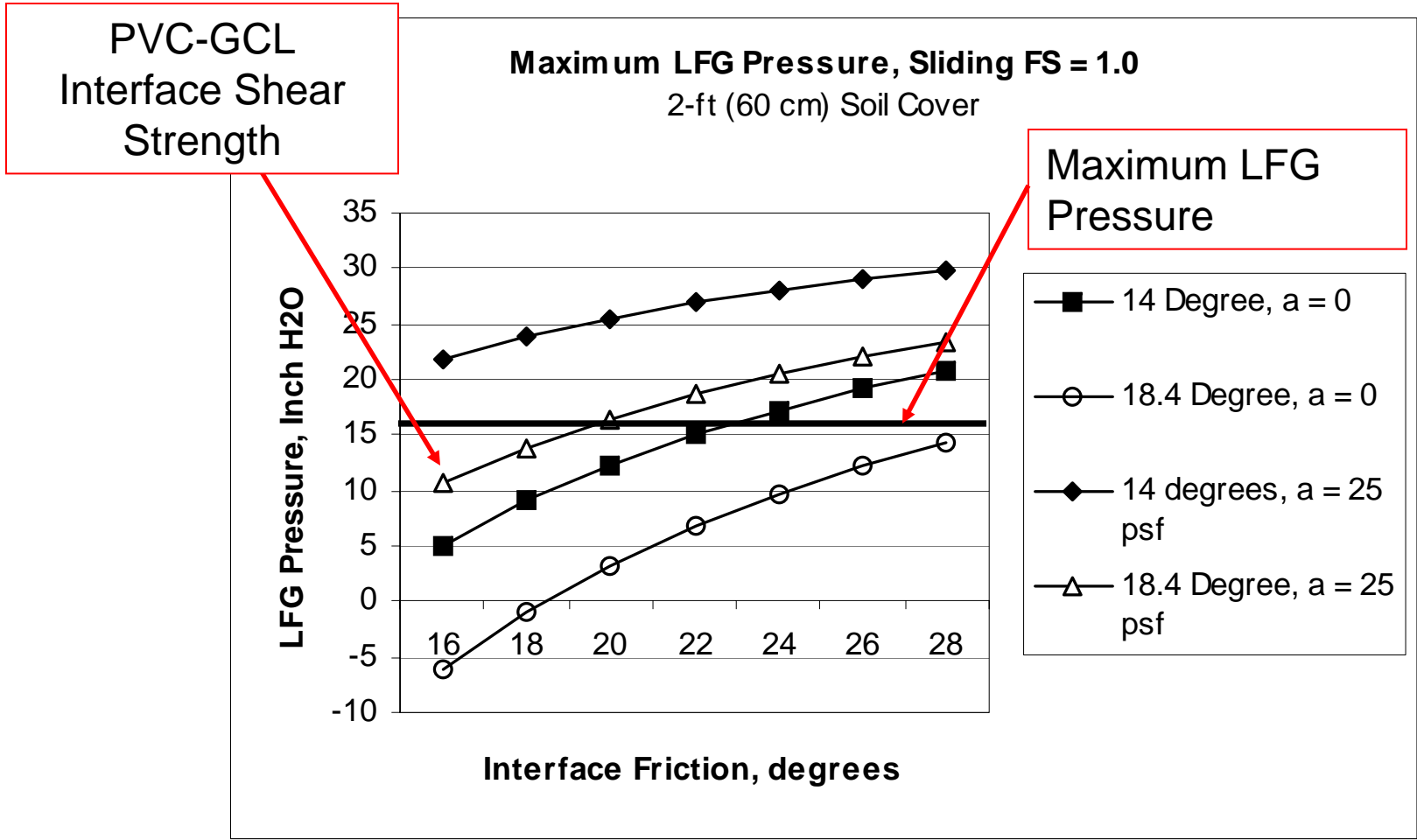

Case Study: Failure During Construction

- The 1-ft thick sand LFG relief layer was found to have been saturated during construction so this layer provided little to no capacity for LFG transmission.
 - **Thus, it's critical to construct LFG relief layers from free draining materials – especially since LFG contains significant moisture.**
- The sand LFG relief layer was retrofitted with strip drains spaced at 29-ft in the cover reconstruction.

Case Study: Post-Construction Failure

Exposed
GCL



Final Cover System on 3H:1V slope with components (top-down):

- 2-ft topsoil and vegetative soil;
- 8 oz/sy nonwoven geotextile
- Text. LLDPE geomembrane (spikes on bottom/drain surface on top);
- GCL having nonwoven side down, woven side up; and
- 1-ft interim soil cover immediately over waste.

Case Study: Post-Construction Failure

- Failure occurred along LLDPE geomembrane/GCL within a few months of completion of the final cover system. The LLDPE geomembrane used was a structured product with conical spikes on the bottom and a studded drain layer (in conjunction with the nonwoven geotextile) on top.
- At the time of discovery of the failure, the active gas recovery system had been down for about one week for maintenance.



Case Study: Post-Construction Failure

- Pre-construction testing of LLDPE GM/GCL interface ($\phi = 29$ degrees; $a = 0$ psf) theoretically stable ($FS > 1.0$) at < 15 inch- H_2O LFG pressure.
- Post-failure testing of LLDPE GM/GCL interface ($\phi = 23.5$ degrees; $a = 0$ psf) theoretically stable ($FS > 1.0$) at < 9 inch- H_2O LFG pressure.
- The significantly lower interface shear strength was attributed to dragging of the geomembrane downslope during deployment. The dragging reduced the asperity height of the spikes (i.e. dulled the tip of the spike).

Case Study: Post-Construction Failure

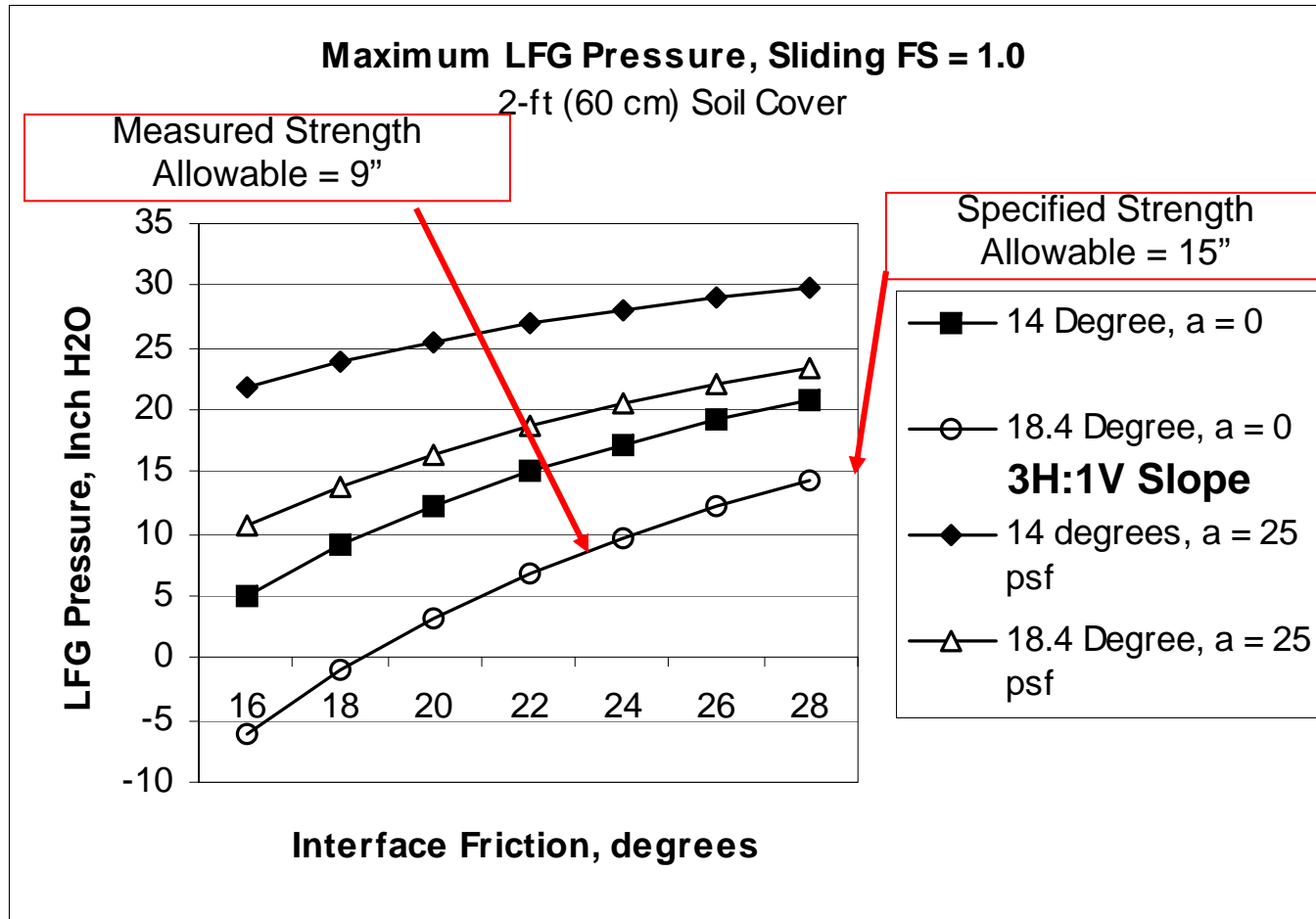

Case Study: Post-Construction Failure

- To evaluate the effect of the active LFG system shutdown, a single recovery well was removed from an active LFG system and the subsequent increase in LFG observed.
- From an initial vacuum of 9-inch H₂O, it took only one hour to achieve a zero pressure. Over the next five (5) hours, the LFG pressure increased to 1.5-inch.
- Thus, **over a 10-inch increase in LFG pressure required less than six (6) hours.** This increase occurred despite the presence of adjacent LFG wells that remained in service and under the full operational vacuum.

Case Study: Post-Construction Failure

- Conservative design would assume that **full LFG pressures would develop in less than two (2) days** if the entire active LFG system shuts down.



Contingent Passive Venting Systems: Piggyback Liner System

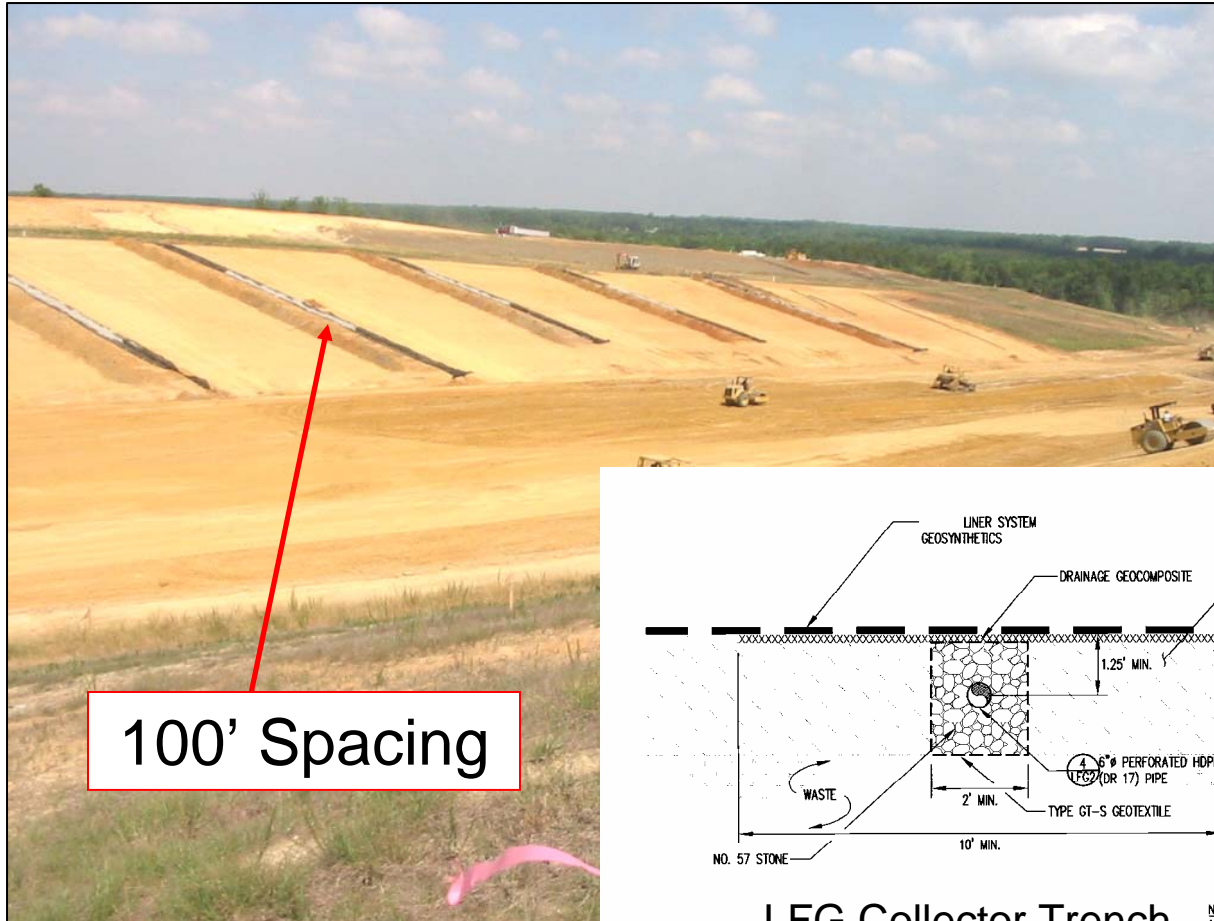

100' Spacing

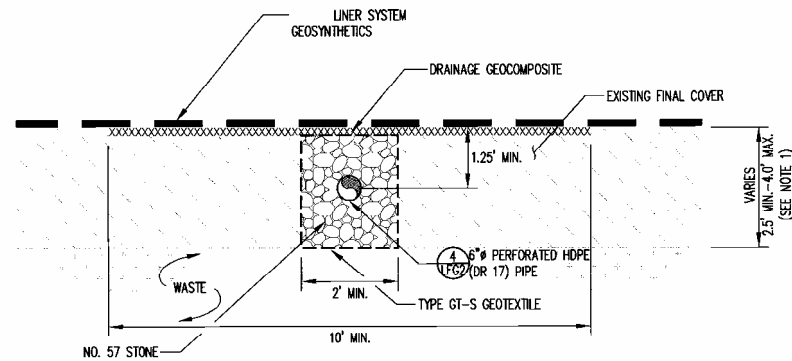

LFG Collector Trench

NOTE:
1. EXCAVATE TRENCH SUCH THAT EXISTING COVER IS BREACHED OR TO A MAXIMUM DEPTH OF 4 FEET.

Contingent Passive Venting Systems: Final Cover System

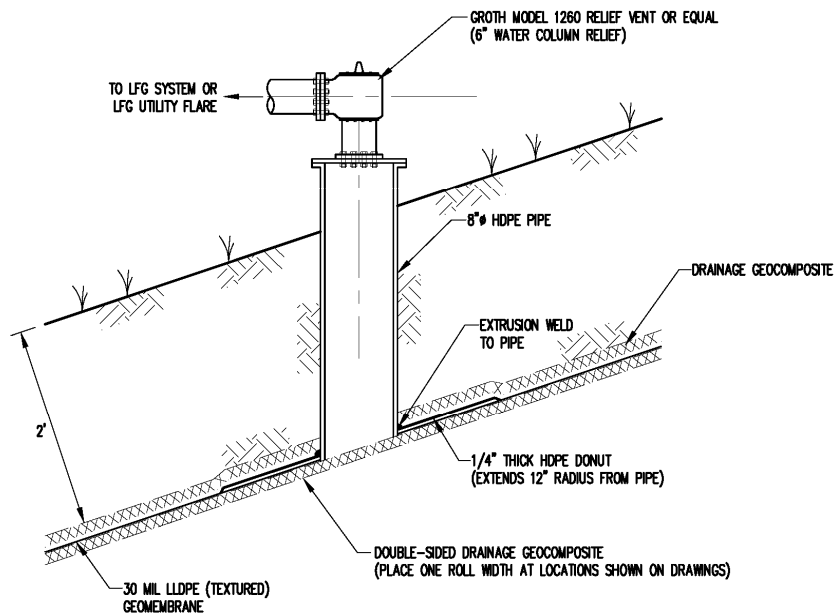

Emergency LFG Relief Vent



- Limit LFG release under normal operations.
- Allow venting of positive LFG pressures.

Summary Points

- 1. It's critical to construct LFG relief layers with free draining materials – especially since LFG contains significant moisture.**
- 2. LFG pressure increases during shutdown of active recovery systems can lead to slope failure.**
 - Conservative design would assume that full LFG pressures would develop in less than two (2) days if the entire active LFG system shuts down.**
- 3. A passive contingent LFG system with relief valves must be installed in landfills using active LFG recovery systems lacking backup compressors/flares.**
- 4. Interface shear strength may be reduced by installation technique, i.e. dragging geomembrane.**

Questions?

Active LFG Control: An Unreliable Aid to Veneer Stability

For More Information:

Richardson Smith Gardner & Associates, Inc.

14 N. Boylan Ave.

Raleigh, NC 27603

+1 919 828 0577

www.rsgengineers.com

Pieter K. Scheer, P.E.
pieter@rsgengineers.com

